

To us, good Luminarie is a matter of  
**problem solving, performance,  
durability, and aesthetics**



Sowood EVO Pendant  
is designed to create  
excellent uniformity on desk surface,  
high visual comfort and express the  
natural beauty of wood veneer.



The color, grain, haptic, character of wood veneer is expressed evenly by special optic which become vision interests in any context

The high-quality, innovative developed lenses produce glare-free(UGR9)and softened lighting onto the table surface which is illuminated precisely and evenly



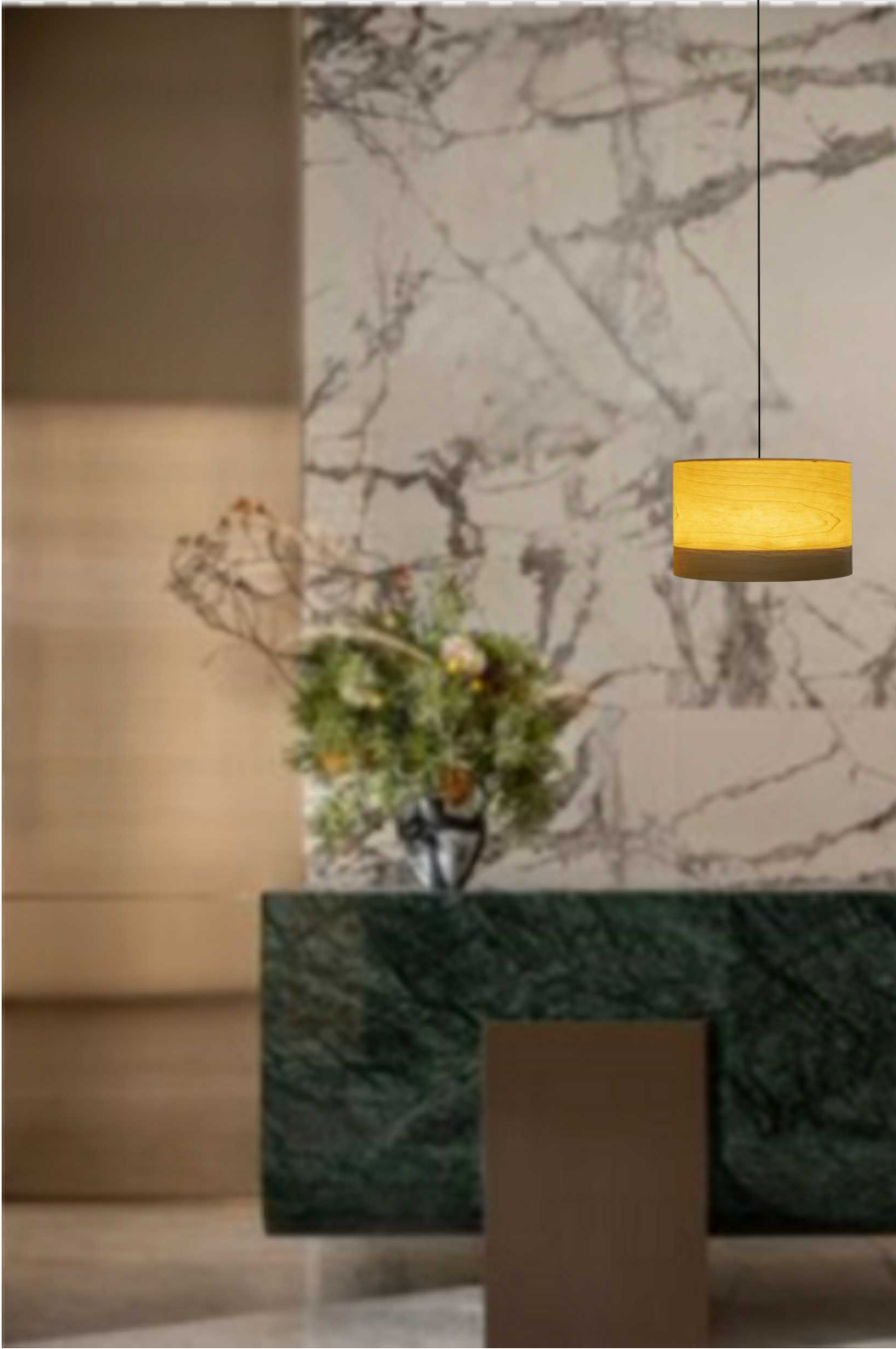

Sowody EVO Pendant creates warm counterbalance to modern, cool surface such as steel, concrete, metal or glass.



Touchless control.

Up and down can be controlled separately and touchlessly with a simple hand gesture.



## Continuous height adjustment

Sowood EVO pendant can be continuously adjusted without the use of tools through a range of 150cm which means a cozy dinner or pleasant games or craft evening or even well-lit workplace for studying or working.





Sowood EVO Pendant is ideal lamp for life quieter moments,  
its glow soft and soothing



Sowood EVO Pendant can be freely applied in any space, from the residential to hospitality, retail, and office



## Conditions of Use

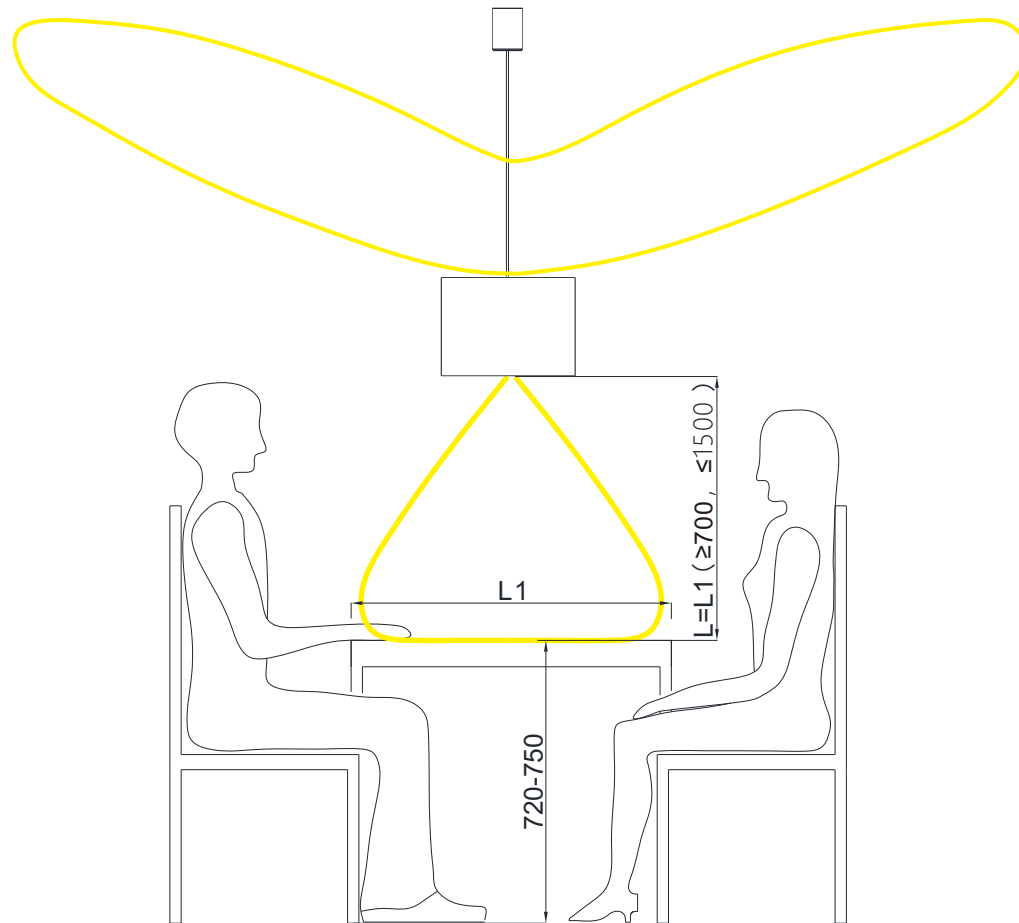

1. The reserved wire must be in the middle of the table
2. The distance between the lamp and the table is equal to the width of the table
3. The recommended length of the dining table is 1.2-1.5 meters
4. ERGONOMIC should be considered

## Lighting distribution

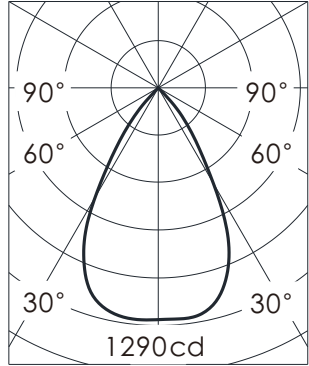

View angle : 60°

Height(m)	Illumination (lx)	Diameter (m)
1	849	1.13
2	213	2.27
3	94	3.40
4	53	4.54
5	34	5.67

Direct luminous flux: 1440lm

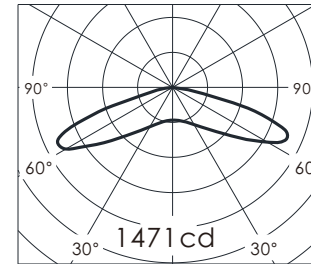

发光角度：160°

高度 (m)	照度 (lx)	直径 (m)
1	109	5.82
2	27.3	11.65
3	12.1	17.40

Indirect luminous lux: 4990lm

## Bin standard

ANSI C78.377

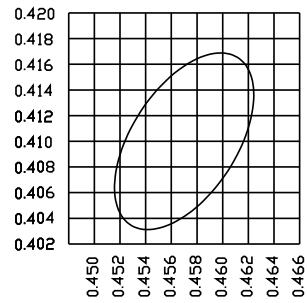

BIN:27A

Centred x	Centred y	Nominal CCT (K)	CCT Range(K)	MacAdam ellipse
0.4578	0.4101	2700	2660-2790	3SDCM

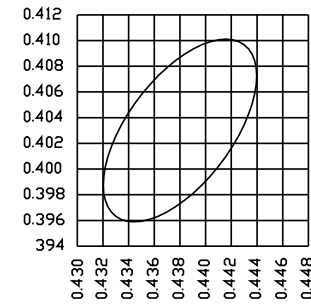

BIN:30A

Centred x	Centred y	Nominal CCT (K)	CCT Range(K)	MacAdam ellipse
0.4338	0.403	3000	2865-2940	3SDCM

## Dimension

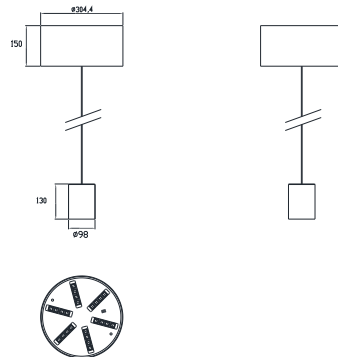

Electrical Characteristics

Voltage Range(V)	22-26
Power /pc (W)	UP 28.8      DOWN 13.5
Driver	Out
Dimable	Touchless
Flicker	high frequency

Optical Characteristics

Light distribution	Direct/Indirect
Luminous lux ( lm )	Indirect 3340      Direct 2106
lighting source(lm/w)	128
Luminare(lm/w)	120
Color quality	2700K: CRI93 Ra95 R9 68 Rf 90 Rg 101 3000K: CRI94 Ra96 R9 72 Rf 92 Rg 101
View angle	UP 160°      DOWN 60°
MacAdam Step	3SDCM
UGR	12
Color temperature	2700K/3000K

Physical Characteristics

Color	Maple
Composition	Maple/Optic/Aluminum/LED
Case	Maple
Dimension (mm)	1280×33×30
Net weight(kg)	0.96

Dependability

Warranty	5 years
Lifespan > 50.000h (Tc=85°C)	L80B50-50.000h(Tc=85°C)
IP	53
Certificate	CE RoHS
Luminare Class	III
IK	Ik03
Temperature	-20 ~ +40°C

## Standards&Certificates

Integrating Sphere Test	IES LM79 (lumen,CCT,CRI,XY,SDCM,wave length)
Photometric Distribution Test	IES LM79
Aging Test	IES LM84&IES TM28
Ambient Temperature Test	UL1598&UL2388&IEC60598-1&IEC60598-2-21
High temperature High Humidity Test	UL1598&UL2388&IEC60598-1&IEC60598-2-21
Bending Test	500 cycles
Vibration Test	UL2388>750cycles
Tensile Test	Defined by Manufacturer
Drop Test	UL1598&UL2388&IEC60598-1&IEC60598-2-21
IK Test	IEC62262
Fire-Rating Test	UI94
UV Test	ASTMG154,ISO4892-3,UVA@340nm IEC60529
Salt Spray Test	IEC68-2-11
Thermal Shock Test	Non-lighting -40°C-55°C ( 25mins ) with 5mins , 100 cycles
High temperature test	55°C

## Packaging



	Qty	Dimension (mm)	Net weight(kg)	Gross Weight(kg)
Inner Box	1	1300*90*60	0.96	2.17

# Installation

